

TYPICAL DETAIL - PARKING DECK MEMBRANE CONCRETE TOPPING OVER DOUBLE T BEAM JOINTS

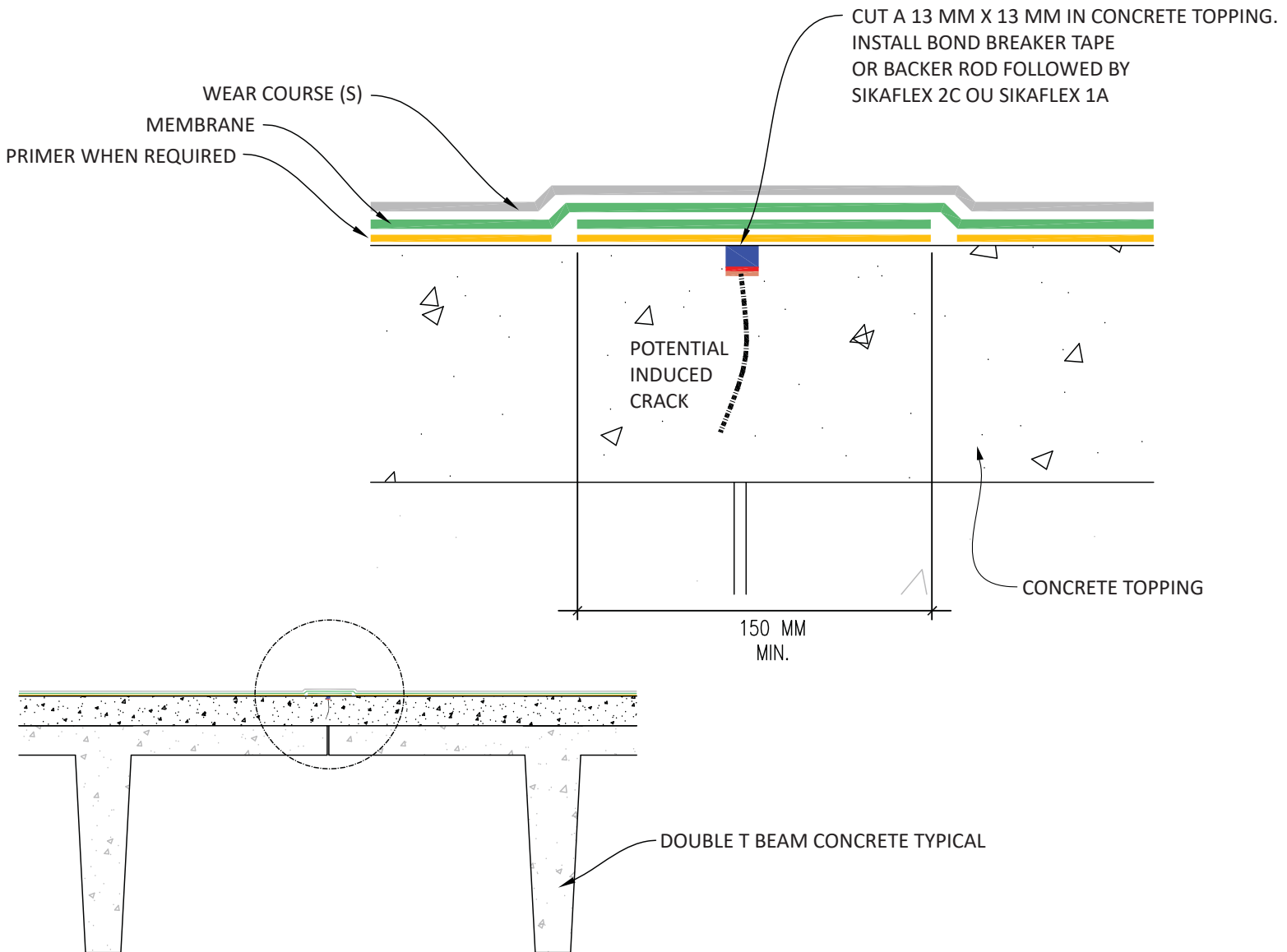

TYPICAL DETAIL - PARKING DECK MEMBRANE CRACKS / JOINTS FROM 1.6 MM TO 25 MM

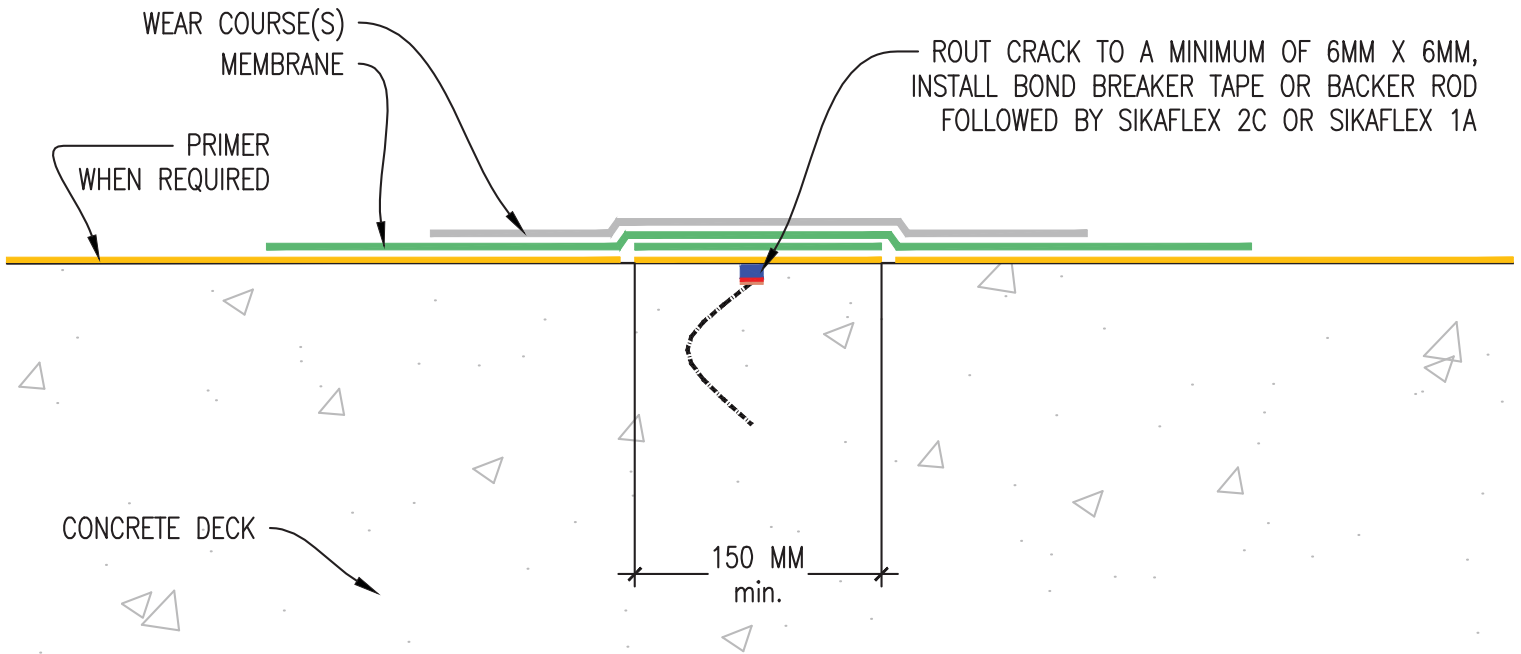

TYPICAL DETAIL - PARKING DECK MEMBRANE CRACKS LESS THAN 1.6MM USUALLY SHRINKAGE CRACKS, NON MOVING

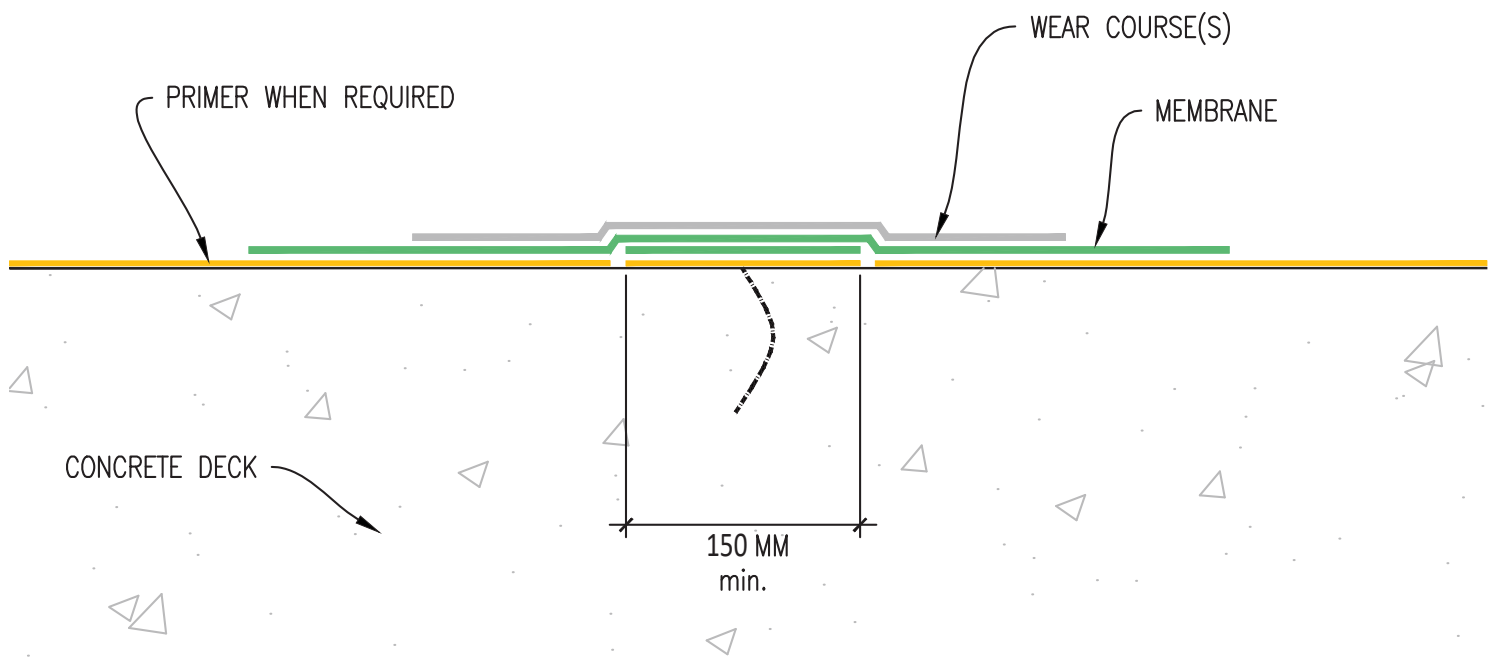

TYPICAL DETAIL - PARKING DECK MEMBRANE JOINTS OVER 25 MM

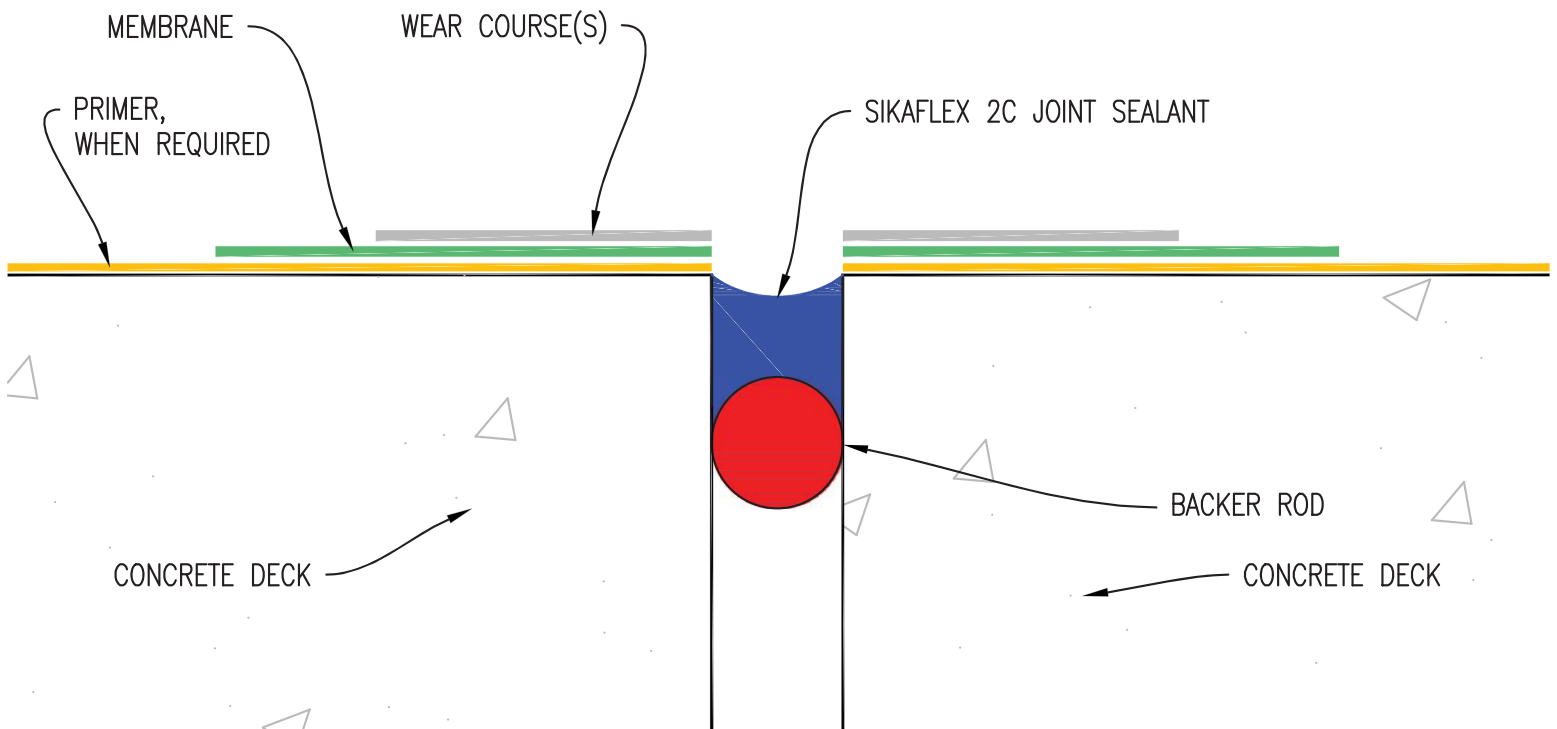

TYPICAL DETAIL - PARKING DECK MEMBRANE METAL POST WITH BASE PLATE

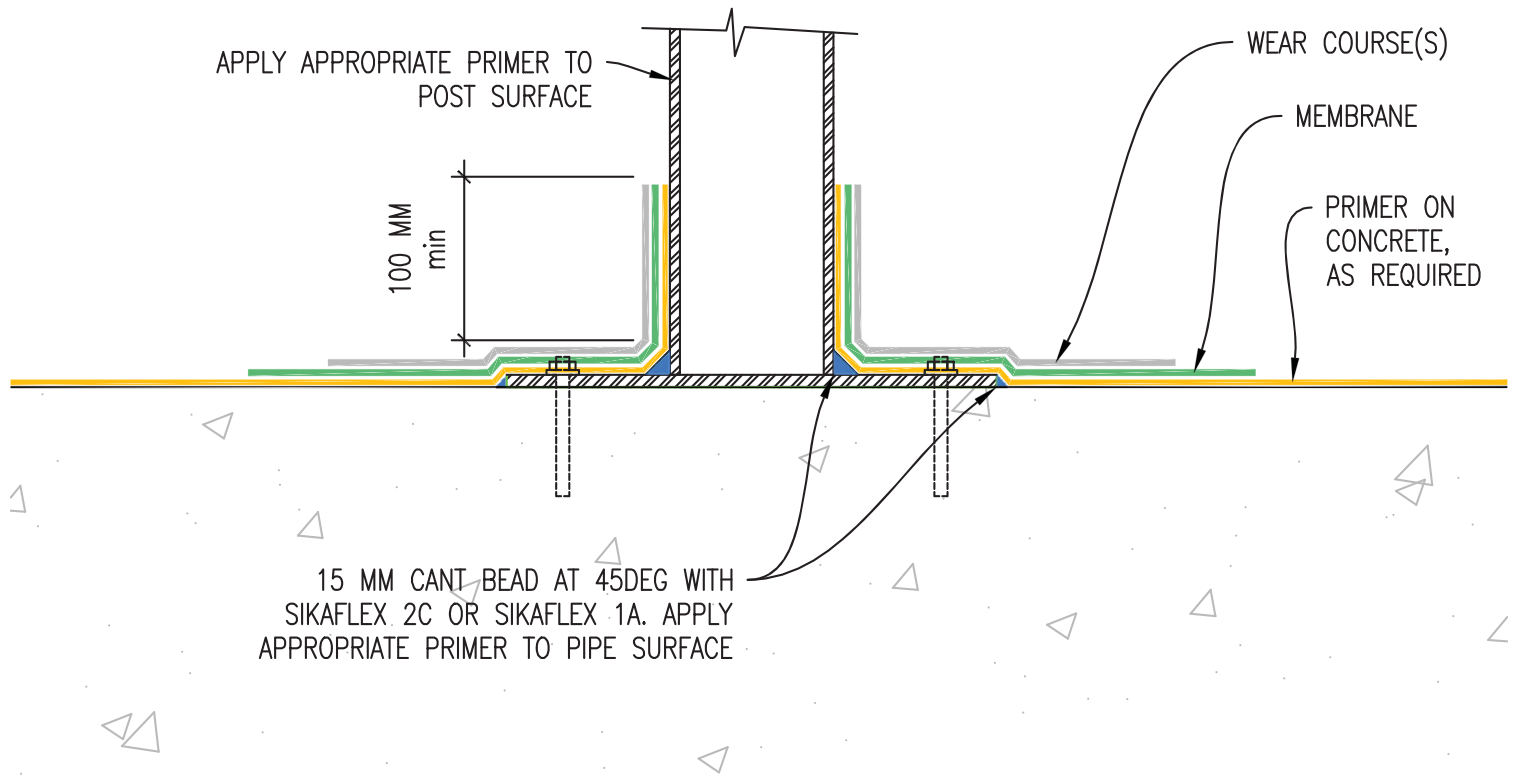

TYPICAL DETAIL - PARKING DECK MEMBRANE TERMINATION WITH WINGED EXPANSION JOINT SYSTEM

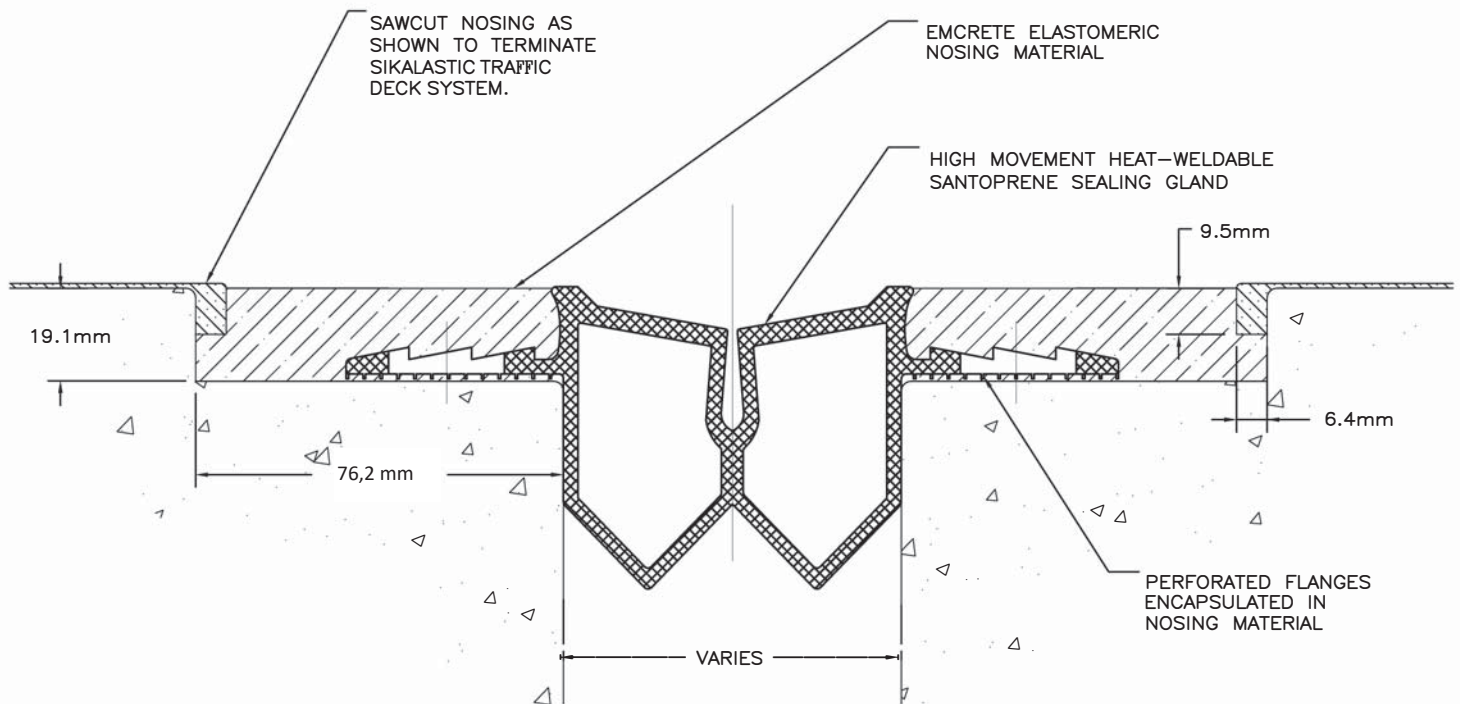

TYPICAL DETAIL - PARKING DECK MEMBRANE DRAIN TERMINATION

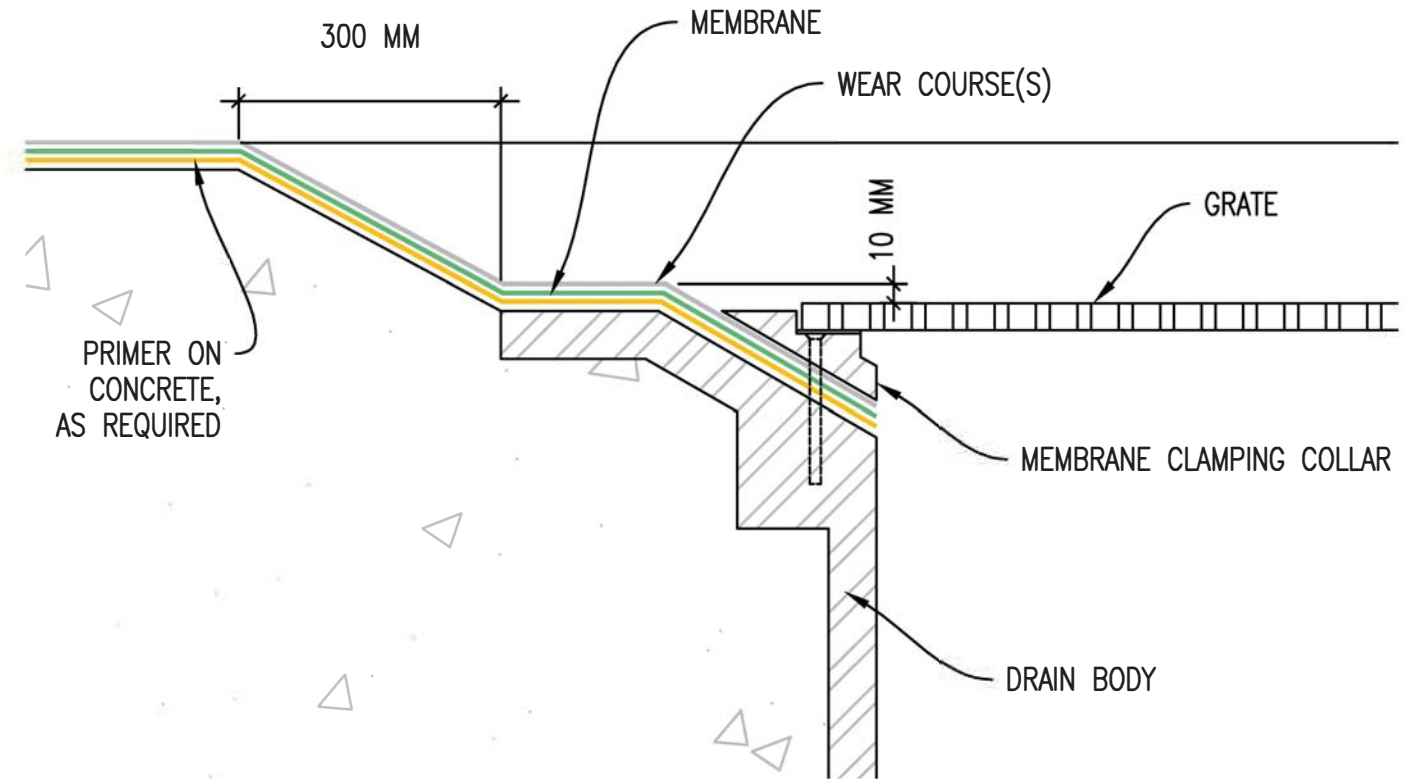

TYPICAL DETAIL - PARKING DECK MEMBRANE PIPE PENETRATION

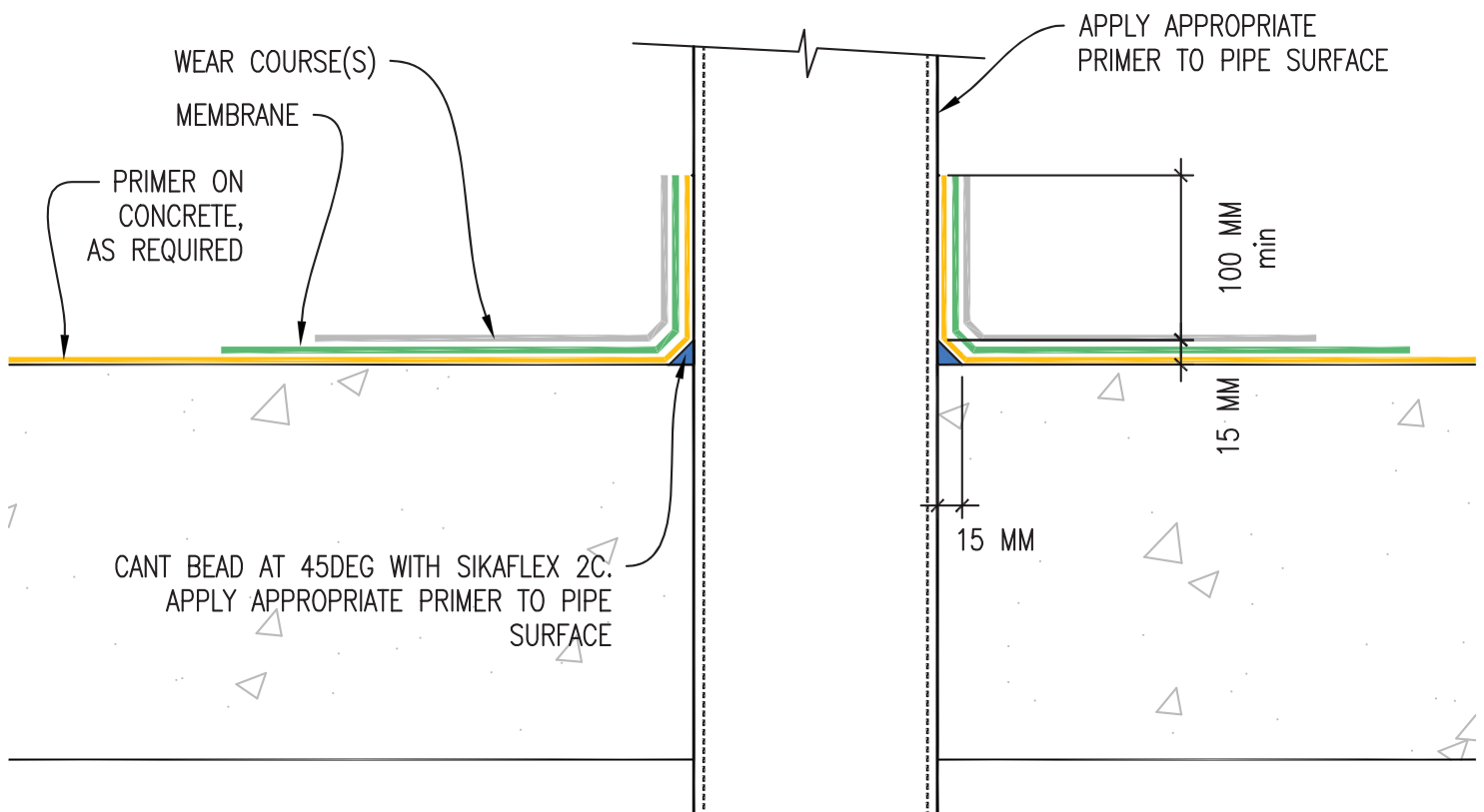

TYPICAL DETAIL - PARKING DECK MEMBRANE VERTICAL SURFACES

